



OPERATOR'S MANUAL COIL TRAILER

MODEL #CT1135TT

2" PIPE MAXIMUM



TABLE OF CONTENTS

OPERATOR'S MANUAL

Safety Alert	1
General Safety	2
Keep Personnel Away	3
Warning	4
Loading Pipe	5
Secure Pipe Before Transporting	6
Maintenance	7
Lubricating	8
Specifications	9
Warranty Sheet	10



EQUIPMENT SAFETY

Safety Alerts

This hazard alert sign  appears in this manual. When you see this sign, carefully read what it says. **YOUR SAFETY IS AT STAKE.**

You will see the hazard alert sign with these words: **DANGER, WARNING, and CAUTION.**

DANGER

Indicates an imminently hazardous situation which, if not avoided, will result in death or serious injury.

WARNING

Indicates a potentially hazardous situation which, if not avoided, could result in death or serious injury.

CAUTION

Indicates a hazardous situation which, if not avoided, may result in minor or moderate injury.

In this manual you should look for two other words: **NOTICE** and **IMPORTANT.**

NOTICE: can keep you from doing something that might damage the machine or someone's property. It may also be used to alert against unsafe practices.

IMPORTANT: can help you do a better job or make your job easier in some way.

Read and Understand

Do not operate this equipment until you have carefully read, and understand the "Safety" and "Operation" sections of this manual, and all other equipment manuals that will be used with it.

Your safety and the safety of others depends upon care and judgment in the operation of this equipment.

Follow all applicable federal, state, local, and industry specific regulations.

We cannot anticipate every possible circumstance that might involve a potential hazard. The warnings in this manual and on the machine are therefore not all inclusive. You must satisfy yourself that a procedure, tool, work method, or operating technique is safe for you and others. You should also ensure that the machine will not be damaged or made unsafe by the method of operation or maintenance you choose.



EQUIPMENT SAFETY

General Safety

Safety is important. Report anything unusual that you notice during set up or operation.

LISTEN for thumps, bumps, rattles, squeals, air leaks, or unusual sounds.

SMELL odors like burning insulation, hot metal, burning rubber, hot oil, or natural gas.

FEEL any changes in the way the equipment operates.

SEE problems with wiring and cables, hydraulic connections, or other equipment.

REPORT anything you see, feel, smell, or hear that is different from what you expect, or that you think may be unsafe.



Wear Safety Equipment

Wear a hard hat, safety shoes, safety glasses, and other applicable personal protective equipment.

Remove jewelry and rings, and do not wear loose-fitting clothing or long hair that could catch on controls or moving machinery.



Cutting Coil Bands

⚠️ WARNING

Coiled pipe can uncoil with considerable force, causing extreme bodily injury if not properly contained. Do not cut the straps around the coil until the coil is contained in a suitable reel trailer or coil cage.

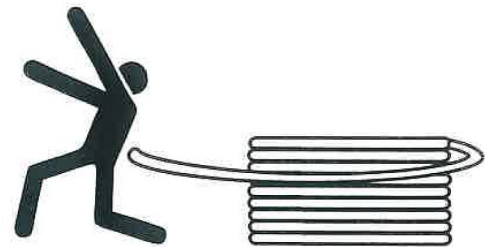

EQUIPMENT SAFETY

Keep Personnel Away

⚠️ WARNING

The rollers in this machine are under hydraulic pressure and can cause severe bodily harm. All personnel must keep hands and body away from moving parts of machine.

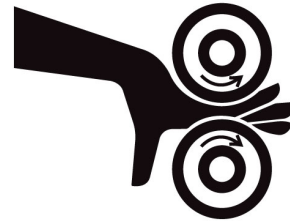

Coil Pipe Safety

When the tail end of the coil unwinds, or when the pipe is being cut, the ends can move suddenly in any direction with great force.

⚠️ WARNING

Loose ends of coiled pipe can move with great force in any direction. Keep personnel at least 15 feet away.

When pulling pipe through the LineTamer®, personnel and equipment must stay at least 15 feet away from machine and pipe ends.



Cold Weather Conditions

Operation below 32° F is not recommended.

The forceful movement of loose ends of pipe become more pronounced in cold weather and all personnel must be aware for their own safety.

There are practical limits to pulling pipe in cold weather. The ability of the pipe to be straightened and rerounded diminishes.

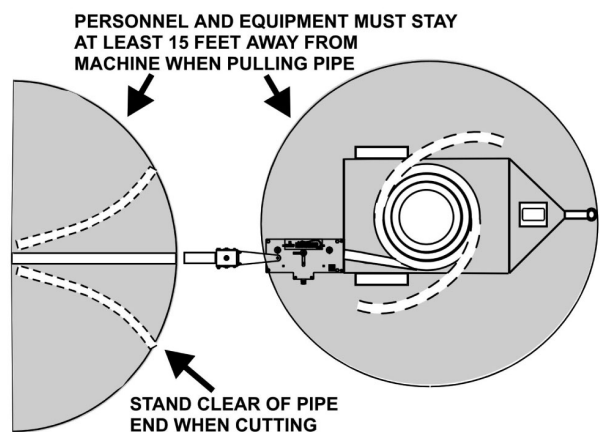



WARNING

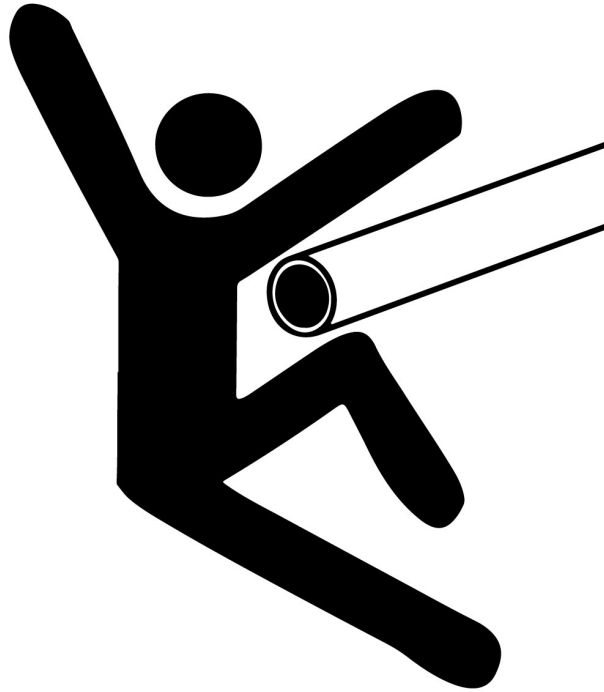

**STAND CLEAR
WHEN OPERATING.
15 FEET MINIMUM**

LOADING PIPE

Lift coil of pipe with fork lift truck and lower onto trailer without removing vertical arms.

Loading Pipe Manually

1. Remove bolts and remove interior vertical arms
2. Remove two outside vertical arms at the rear of the trailer.
3. Load the coil of pipe onto the turn table and position it in the center.
4. Replace interior and outside vertical arms and bolt them into position.
5. Adjust the turntable adjustable brake (if equipped) by releasing the brake lever and turning the knob on the end of the lever (clockwise to tighten and counterclockwise to loosen), and resetting the brake.

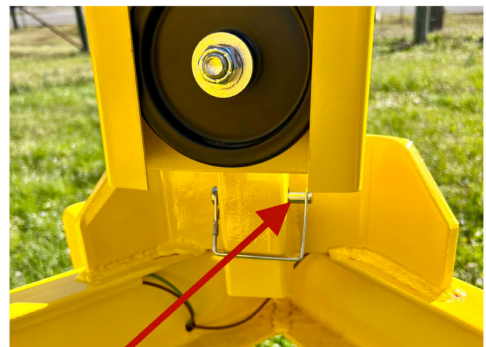

TRANSPORTING

Secure Pipe Before Transporting

The coil of the pipe should be secured in the trailer before transporting. Use locking straps or similar means to secure the coil to itself as well as the trailer frame. This will prevent damage to the pipe and trailer from shifting loads at trailering speeds.

The Line Tamer must also be secured to the trailer with suitable strap prior to towing the trailer.

Be sure locking pins are installed before traveling.

Read Before Towing Trailer

Never tow a trailer before you check to be sure of the following:

Check to assure brakes are operating.

Coupler and hitch are the right size.

Coupler and safety chains are safely secured to hitch.

Trailer jack is in the raised position.

Check all fasteners for proper tightness.

Wheel lug nuts are properly tightened.

Wheel bearings are properly adjusted and maintained.

Load is within maximum load carrying capacity.
Tires are properly inflated.

All trailer lighting is working properly.

Following all federal, state, local and industry standards

Break away switch cable is attached to tow vehicle.

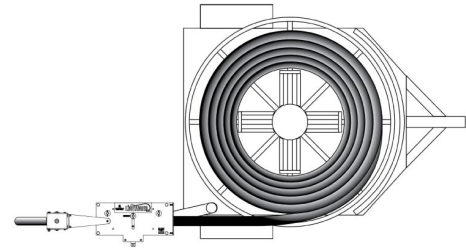
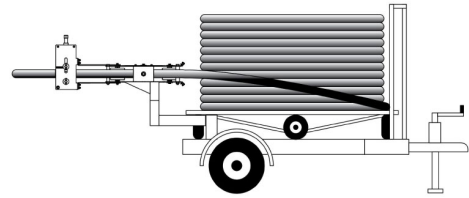

PIN MUST ALWAYS BE FULLY INSERTED INTO BREAKAWAY SWITCH. REMOVING PIN (AS SHOWN) WILL ACTIVATE BRAKES, & MAY DAMAGE TIRES, BRAKES, BATTERY, WIRING, & OTHER PARTS.



MAINTENANCE

Preventative Maintenance

To insure optimum performance, the machine must be kept clean and well maintained.

With reasonable care, this machine will give years of service. Therefore, it is important that a regular schedule of preventive maintenance be kept.

Store machine inside, out of the weather, whenever possible.

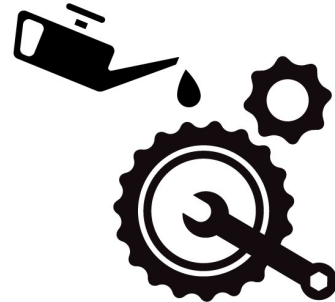

Washing the Machine

An important factor in the service life of this machine is cleanliness. The machine should be cleaned with soap and water as needed.

When exposed to dust and mud in a field location, the machine should be washed at the end of each days work.



Brake System

Periodically check electric brake breakaway switch battery for full charge.

Check wires and connections to brakes for damage. Repair or replace parts as required.



MAINTENANCE

Grease

All moving parts should be greased periodically.



Check the grease level in your Trailer Buddy Axle before you launch.

If the blue *Auto-Check*[®] ring is visible you do not need to add grease.

Full



TO GREASE:

- ★ Use only high quality grade 2 wheel bearing grease from a hand operated grease gun.
- ★ Remove stainless steel cap and add grease through grease fitting until blue *Auto-Check*[®] ring sticks out 1/8" to 1/4"

Grease Needed



TRAILER
Buddy[®]
AXLES BY **UFP**
San Marcos, CA • Winchester, TN

32478

Five Year Limited Warranty

Guaranteed against bearing failure and defects in workmanship and materials
Refer to service manual for details. 760-744-1610

Check axles for grease.
Follow manufacturer's recommendations.





MODEL: CT1135TT

SPECIFICATIONS

DESCRIPTION

MODEL - CT1135TT
GVWR - 3,500 lbs.
2" Pipe Maximum
Empty Weight - 940 lbs.
Carrying Capacity - 2,560 lbs.
Overall Length - 13 ft.
Overall Width - 88 in.
Overall Height - 7 ft. 4 in.
Maximum Coil OD - 80 in.
Minimum Coil ID - 45 in.
Maximum Coil ID - 50 in.

RUNNING GEAR

Single Axle - 3,500 lbs.
Brakes - Electric
Tires - ST205/75R14 LRD
Wheels - 14 x 6 5 Bolt Mod
Suspension - Leaf Spring

FRAME

Main Frame - 5" Channel
Turntable - 80" with 4 Roller Supports
Turntable Spindle - 3,500 lbs. with Standard Bearings
4 Supports Outside
4 Adjustable Supports Inside
Tongue - Adjustable Pintle Eye
Fenders - 16 ga.

ELECTRICAL

Plug - 7 RV Molded Plug
Wiring - Enclosed in Tube with Junction Box
Lights - Protected Standard LED

SAFETY

Chains - 1/4" with Hook
Breakaway - Battery, Battery Box and Switch
Decals - Warning Decals and Reflective Tape

FINISH

Sherwin-Williams Paint
Industrial Urethane Yellow

AVAILABLE OPTIONS

Optional Turntable Brake (TB1)





127 Industrial Park Rd, Sweetwater, TN 37874
Office: 423.337.3466 · Fax: 423.337.7208
www.pipetrailer.com

Sweetwater Metal Products “Limited One (1) Year Warranty”

Sweetwater Metal Products – Sweetwater, TN 37874-3055, provides the following limited one (1) year warranty on products manufactured by it to the purchaser of such products and to any person to whom such product is transferred during the duration of this warranty.

The warrantor’s obligation shall be limited to repairing or replacing at the factory in Sweetwater, TN 37874, any part or parts which shall within the one (1) year period hereinafter specified be returned to it with transportation prepaid and which upon examination by Sweetwater Metal Products shows to have been defective. This warranty shall not apply if:

- (A) The product has been altered, repaired or modified outside the warrantor’s factory in any way that would adversely affect its operation.
- (B) The product has been subjected to misuse or damage while in the possession of the purchaser or any person to whom the product was transferred by the purchaser or was installed or operated other than in accordance with the manufacturer’s operating instructions.
- (C) The product was used with accessories not recommended by Sweetwater Metal Products or for loads in excess of those listed as rated for the product.

The one (1) year limited warranty period shall commence with the date the product is sold to the purchaser by the dealer or, if this date cannot be established, the date the product was sold by Sweetwater Metal Products.

The implied warranties of merchantability and fitness for particular purpose are limited to the duration of this warranty – one (1) year – after said one (1) year, Sweetwater Metal Products expressly disclaims any warranty of merchantability or fitness for any particular purpose.

Purchase or other acceptance of the product by the claimant shall be on the condition and agreement that Sweetwater Metal Products shall not be liable for incidental or consequential damages of any kind.

Sweetwater Metal Products shall not be liable for paint damage due to rock chipping.

Tires are not included under the one (1) year warranty and should the purchaser find them unsatisfactory, should make a claim directly to the tire manufacturer.

To make a claim under this warranty, write directly to Sweetwater Metal Products – 127 Industrial Park Rd – Sweetwater, TN 37874-3055, identifying the product and giving its location. Return instructions will be provided by the company. Sweetwater Metal Products will make its best efforts to repair or replace the products, if found to be defective within the terms of this warranty, within sixty (60) days after return of the product to the company.

In order to validate warranty, fill out the accompanying warranty registration card and return with ten (10) days from the date of purchase.